

## POINT MICROMETERS

- Measure the web thickness of drills, small grooves and keyways
- Graduation 0.01mm
- Ratchet stop
- Carbide tips
- Supplied with setting standards (except 0-25mm)



3230-25A

(mm)

Code	Range	Type	Accuracy	L	b
3230-25A	0-25mm	A	4µm	57	32
3230-50A	25-50mm	A	4µm	82	44.5
3230-75A	50-75mm	A	5µm	107	57
3230-100A	75-100mm	A	5µm	132.6	69.5
3230-25BA	0-25mm	B	4µm	57	32
3230-50BA	25-50mm	B	4µm	82	44.5
3230-75BA	50-75mm	B	5µm	107	57
3230-100BA	75-100mm	B	5µm	132.6	69.5

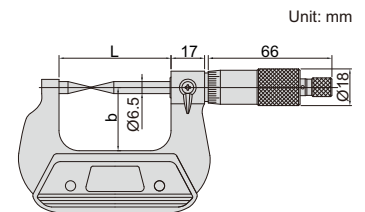
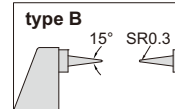
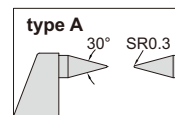

DATA  
OUTPUT

IP65  
WATERPROOF

## DIGITAL POINT MICROMETERS

- Measure the web thickness of drills, small grooves and keyways
- Resolution 0.001mm/0.00005"
- IP65 dust/waterproof
- Button function: on/off, set, mm/inch, ABS/INC
- Data output
- Automatic power off
- Ratchet stop
- Carbide tips
- Supplied with setting standards (except 0-25mm/0-1")
- Optional accessory: data output cable (code 7315-30, 7302-30)



3530-25A

(mm)

Code	Range	Type	Accuracy	L	b
3530-25A	0-25mm/0-1"	A	±4µm	57	32
3530-50A	25-50mm/1-2"	A	±4µm	82	44.5
3530-75A	50-75mm/2-3"	A	±5µm	107	57
3530-100A	75-100mm/3-4"	A	±5µm	132.6	69.5
3530-25BA	0-25mm/0-1"	B	±4µm	57	32
3530-50BA	25-50mm/1-2"	B	±4µm	82	44.5
3530-75BA	50-75mm/2-3"	B	±5µm	107	57
3530-100BA	75-100mm/3-4"	B	±5µm	132.6	69.5

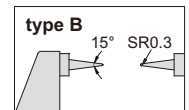
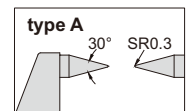
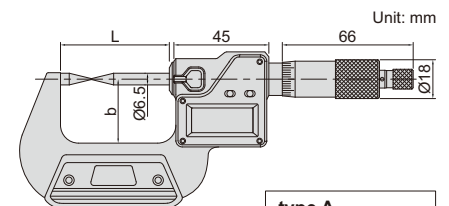



# HIGH PRECISION DIGITAL POINT MICROMETERS/SNAP GAGES



ABSOLUTE ENCODER, THE ORIGINAL DATA REMAINS AFTER POWER OFF

ONE TURN OF SLEEVE MAKES 5MM SPINDLE FEED, PRESS THE FORK, THE SPINDLE RETRACTS 3MM

**IP65**  
WATERPROOF

MEASUREMENT ACCURACY IS NOT AFFECTED BY THE USE OF SLEEVE

NON-ROTATING SPINDLE

ATTENTION: RECHARGEABLE BATTERY, FOR 24 HOURS CONTINUOUS WORKING

DATA OUTPUT



3354-25

- Measure the web thickness of drills, small grooves and keyways
- Absolute encoder, the original data remains after power off
- Adjustable resolution: 0.0002mm/0.00001"  
0.001mm/0.00005"  
0.01mm/0.0005"
- One turn of sleeve makes 5mm spindle feed
- Measurement accuracy is not affected by the use of sleeve
- Press the fork, the spindle retracts 3mm
- Linear ball bearings for ten million times use
- Carbide spindle and anvil
- Measuring force 7-10N  
Customizable measuring force range 2-12N  
Attention: small measuring force will reduce the dustproof and waterproof level
- Button function: data output, tolerance, data preset, data hold, measuring direction change, max./min./TIR, power off time, on/off, zero, mm/inch, adjust resolution
- Supplied with gage blocks for zero setting (except 0-25mm/0-1")
- Power: rechargeable battery, for 24 hours continuous working

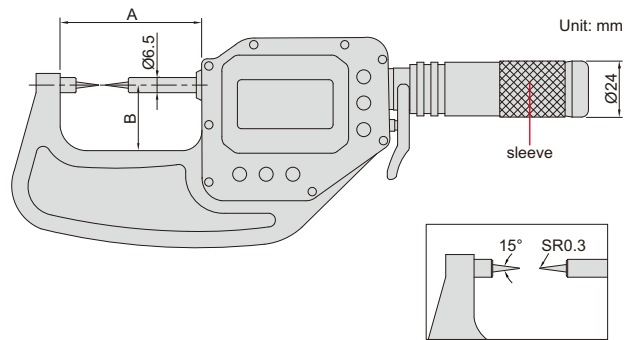

### With data interface

Optional accessory:

wireless transmitter, code 7315-3350, wireless receiver, code 7315-2, 7315-3

data output cable (keyboard format), code 7302-3350

data output cable (serial port format), code 7305-G60

(cable length 3m, optional cable length maximum 15m; RS232 protocol, optional RS485 protocol)

Code	Range	Accuracy	Repeatability	A	B
3354-25 *	0-25mm/0-1"	2µm	1µm	63mm	25mm
3354-50 *	25-50mm/1-2"	2µm	1µm	88mm	42mm
3354-75 *	50-75mm/2-3"	2µm	1µm	113mm	56mm

### Built-in wireless

Optional accessory:

wireless receiver (keyboard format, connect up to 15 digital indicators), code 2134-R1

wireless receiver (serial port format, connect up to 15 digital indicators), code 2134-R2

Code	Range	Accuracy	Repeatability	A	B
3354-25WL *	0-25mm/0-1"	2µm	1µm	63mm	25mm
3354-50WL *	25-50mm/1-2"	2µm	1µm	88mm	42mm
3354-75WL *	50-75mm/2-3"	2µm	1µm	113mm	56mm

\* Supplied with manufacturer inspection certificate

warning when over tolerance

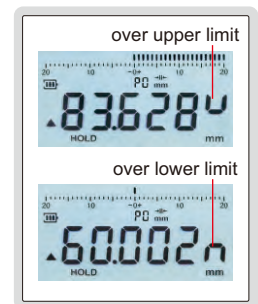

wireless receiver  
2134-R1, 2134-R2 (optional)

